



OWNER'S MANUAL

Split-type Room Air Conditioner

GDC-SS24RCW

Please read the operating instructions and safety precautions carefully and thoroughly before installing and operating your room air conditioner.

CONTENTS

SAFETY PRECAUTIONS	1
PARTS NAMES	4
MANUAL OPERATION	5
OPTIMAL OPERATION	5
ADJUSTING AIR FLOW DIRECTION.....	6
HOW THE AIR CONDITIONER WORKS.....	7
MAINTENANCE.....	8
OPERATION TIPS	10
TROUBLESHOOTING TIPS.....	12

Read This Manual

Inside you will find many helpful hints on how to use and maintain your air conditioner properly. Just a little preventative care on your part can save you a great deal of time and money over the life of your air conditioner. You'll find many answers to common problems in the chart of troubleshooting tips. If you review the chart of Troubleshooting Tips first, you may not need to call for service.





CAUTION

- Contact an authorised service technician for repair or maintenance of this unit.
- Contact the installer for installation of this unit.
- The air conditioner is not intended for use by young children or invalids without supervision.
- Young children should be supervised to ensure that they do not play with the air conditioner.
- If the power cord is to be replaced, replacement work shall be performed by authorised personnel only.
- Installation work must be performed in accordance with the national wiring standards by authorised personnel only.



Safety Precautions

To prevent injury to the user or other people and property damage, the following instructions must be followed.

Incorrect operation due to ignoring of instructions may cause harm or damage. The seriousness is classified by the following indications.

 WARNING	This symbol indicates the possibility of death or serious injury.
 CAUTION	This symbol indicates the possibility of injury or damage to property.

■ Meanings of symbols used in this manual are as shown below.

	Never do this.
	Always do this.

WARNING

Ⓢ Connect with the power properly.

- Otherwise, it may cause electric shock or fire due to excess heat generation.

Ⓢ Do not operate or stop the unit by inserting or pulling out the power plug.

- It may cause electric shock or fire due to heat generation.

Ⓢ Do not damage or use an unspecified power cord.

- It may cause electric shock or fire.

Ⓢ Do not modify power cord length or share the outlet with other appliances

- It may cause electric shock or fire due to heat generation.

Ⓢ Do not operate with wet hands or in damp environment.

- It may cause electric shock.

Ⓢ Do not direct airflow at room occupants only.

- This could damage your health.

Ⓢ Always ensure effective earthing.

- No earthing may cause electric shock.

Ⓢ Do not allow water to run into electric parts.

- It may cause failure of machine or electric shock.

Ⓢ Always install circuit breaker and a dedicated power circuit.

- No installation may cause fire and electric shock.

Ⓢ Disconnect the power if strange sounds, smell, or smoke comes from it.

- It may cause fire and electric shock.

Ⓢ Do not use the socket if it is loose or damaged.

- It may cause fire and electric shock.

Ⓢ Do not open the unit during operation.

- It may cause electric shock.

Ⓢ Keep firearms away.

- It may cause fire.

Ⓢ Do not use the power cord close to heating appliances.

- It may cause fire and electric shock.

Ⓢ Do not use the power cord near flammable gas or combustibles, such as gasoline, benzene, thinner, etc.

- It may cause an explosion or fire.

Ⓢ Ventilate room before operating air conditioner if there is a gas leakage from another appliance.

- It may cause explosion, fire and, burns.

Ⓢ Do not disassemble or modify unit.

- It may cause failure and electric shock.

 **CAUTION**

⊗ When the air filter is to be removed, do not touch the metal parts of the unit.

- It may cause an injury.

⊗ Do not clean the air conditioner with water.

- Water may enter the unit and degrade the insulation. It may cause an electric shock.

⊗ Ventilate the room well when used together with a stove, etc.

- An oxygen shortage may occur.

⊗ When the unit is to be cleaned, switch off, and turn off the circuit breaker.

- Do not clean unit when power is on as it may cause fire and electric shock, it may cause an injury.

⊗ Do not put a pet or house plant where it will be exposed to direct air flow.

- This could injure the pet or plant.

⊗ Do not use for special purposes.

- Do not use this air conditioner to preserve precision devices, food, pets, plants, and art objects. It may cause deterioration of quality, etc.

⊗ Stop operation and close the window in storm or hurricane.

- Operation with windows opened may cause wetting of indoor and soaking of household furniture.

⊗ Hold the plug by the head of the power plug when taking it out.

- Failure to do so may cause electric shock and damage.

⊗ Turn off the main power switch when not using the unit for a long time.

- It may cause failure of product or fire.

⊗ Do not place obstacles around air-inlets or inside of air-outlet.

- It may cause failure of appliance or accident.

⊗ Ensure that the installation bracket of the outdoor appliance is not damaged due to prolonged exposure.

- If bracket is damaged, there is concern of damage due to falling of unit.

⊗ Always insert the filters securely. Clean filter once every two weeks.

- Operation without filters may cause failure.

⊗ Do not use strong detergent such as wax or thinner. Use a soft cloth for cleaning.

- Appearance may be deteriorated due to change of product color or scratching of its surface.

⊗ Do not place heavy object on the power cord and take care so that the cord is not compressed.

- There is danger of fire or electric shock.

⊗ Do not drink water drained from air conditioner.

- It contains contaminants and could make you sick.

⊗ Use caution when unpacking and installing. Sharp edges could cause injury.

⊗ If water enters the unit, turn the unit off at the power outlet and switch off the circuit breaker. Isolate supply by taking the power-plug out and contact a qualified service technician.

Prior to Operation

1. Contact an installation specialist for installation.
2. Make sure the unit is grounded efficiently.
3. Do not use a damaged or non-standard power cord.
4. Do not share the same outlet with other appliances.
5. Do not use an extension cord.
6. Do not start/stop operation by shutting off the power supply.

Usage

1. Exposure to direct airflow for an extended period of time could be hazardous to your health. Do not expose occupants, pets, or plants to direct airflow for extended periods of time.
2. Due to the possibility of oxygen deficiency, ventilate the room when used together with stoves or other heating devices.
3. Do not use this air conditioner for non-specified special purposes (e.g. Preserving precision devices, food, pets, plants, and art objects). Usage in such a manner could harm such property.

Cleaning and maintenance

1. Do not touch the metal parts of the unit when removing the filter. Injuries can occur when handling sharp metal edges.
2. Do not use water to clean inside the air conditioner. Exposure to water can destroy the insulation, leading to possible electric shock.
3. When cleaning the unit, first make sure that the power and circuit breaker are turned off.

Service

For repair and maintenance, contact your authorised service dealer.

Operating temperature

Mode	Cooling operation	Heating operation	Drying operation
Room temperature	17°C ~ 32°C	17°C ~ 30°C	17°C ~ 32°C
Outdoor temperature	18°C ~ 43°C	-7°C ~ 24°C	18°C ~ 43°C

CAUTION:

1. If air conditioner is used outside of the above conditions, certain safety protection features may come into operation and cause the unit to function abnormally.
2. Room relative humidity less than 80%. If the air conditioner operates in excess of this figure, the surface of the air conditioner may attract condensation. Please sets the vertical air flow louver to its maximum angle (vertically to the floor), and set HIGH fan mode.
3. Optimum performance will be achieved within these operating temperature.

PARTS NAMES

Indoor unit

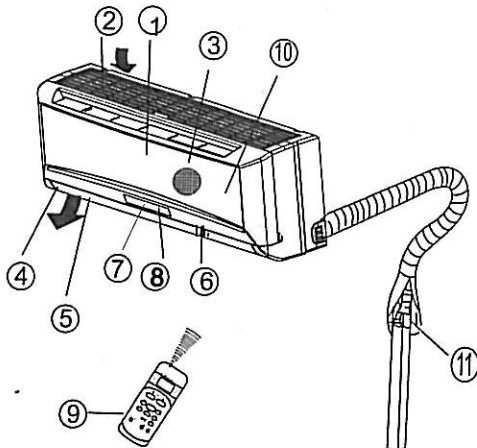

Indoor unit

1. Front panel
2. Air inlet
3. Air filter
4. Air outlet
5. Horizontal air flow grille
6. Vertical air flow louver
7. Display panel
8. Remote controller signal receiver
9. Remote controller
10. Manual control button

Outdoor unit

11. Connecting pipe, drain hose
12. Air inlet (side and rear)
13. Air outlet

Outdoor unit

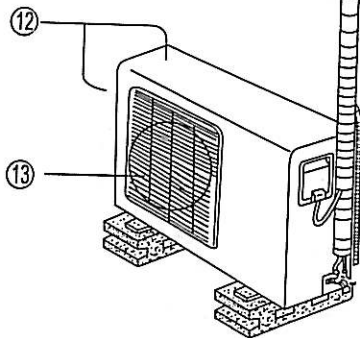

The operation indicator lights flash rapidly (five times per second.) when safety protection features come into operation.

Note:

All the pictures in this manual are for explanation purpose only. They may be slightly different from the air conditioner you purchased (depend on model). The actual shape shall prevail.

Function indicators on indoor unit display panel

The display panel of indoor unit will look like one of the following pictures:

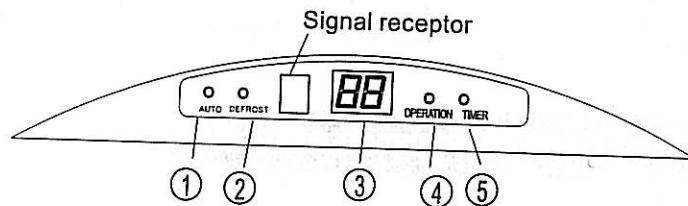
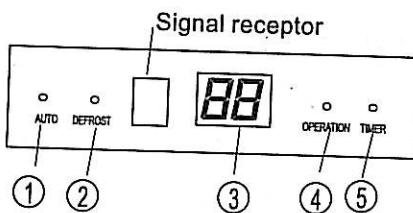

Note: For cooling only models (>21000Btu/h unit), ② indicator light is FAN ONLY.

- ① **AUTO indicator**
This indicator illuminates when the air conditioner is in AUTO operation.
- ② **DEFROST indicator (For Cooling & Heating models only)**
This indicator illuminates when the air conditioner starts defrosting automatically or when the warm air control feature is activated in heating operation.
- ③ **TEMPERATURE indicator**
Displays the temperature settings when the air conditioner is operational.
- ④ **OPERATION indicator**
This indicator flashes after power is on and illuminates when the unit is in operation.
- ⑤ **TIMER indicator**
This indicator illuminates when TIMER is set ON/OFF.

MANUAL OPERATION

Manual operation can be used temporarily in case you can not find the remote controller or its batteries are exhausted.

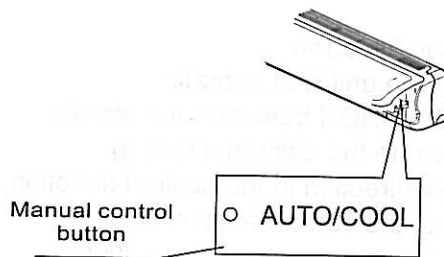
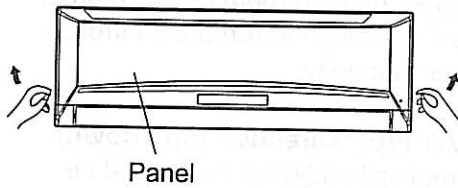

- ① Open and lift the front panel up to an angle until it remains fixed with a clicking sound.
- ② One press of the manual control button will lead to the forced AUTO operation.
- ③ Close the panel firmly to its original position.

CAUTION:

- Once you push the manual button, the operation mode is shifted in an order as: AUTO, COOL, OFF.
- Push the button twice, the unit will operate in forced COOL mode. This is used for testing purposes only.
- Third press will stop the operation and turn off the air conditioner operation.
- To restore the remote controller operation, use the remote controller directly.

OPTIMAL OPERATION

To achieve optimal performance, please note the following:

- Adjust the air flow direction correctly so that it is not directed on people.
- Adjust the temperature to achieve the highest comfort level. Do not adjust the unit to excessive temperature levels.
- Close doors and windows on COOL or HEAT modes, or performance may be reduced.
- Use TIMER ON button on the remote controller to select a time you want to start your air conditioner.
- Do not put any object near air inlet or air outlet, as the efficiency of the air conditioner may be reduced and the air conditioner may stop running.
- Clean the air filter periodically, otherwise cooling or heating performance may be reduced.
- Do not operate unit with horizontal louvre in closed position.

ADJUSTING AIR FLOW DIRECTION

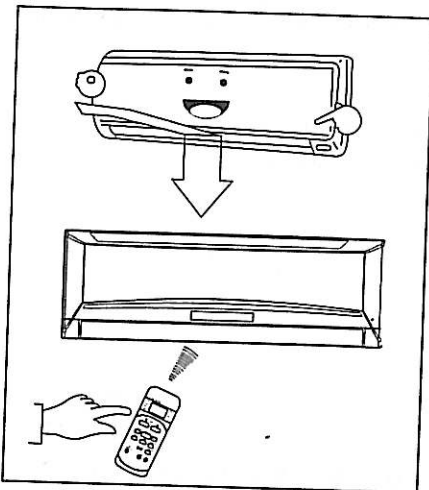

- Adjust the air flow direction properly otherwise, it might cause discomfort or cause uneven room temperatures.
- Adjust the horizontal louver using the remote controller.
- Adjust the vertical louver manually.

Adjusting the Vertical Air Flow Direction (up - down)

The air conditioner automatically adjusts the vertical air flow direction in accordance with the operating mode.

To set the vertical air flow direction

Perform this function while the unit is in operation.

Keep pressing the AIR DIRECTION button on the remote controller to move the louver to the desired direction.

- Adjust the vertical air flow direction to the desired direction.
- In subsequent operations, the vertical air flow is automatically set in the direction to which you adjusted the louver by pressing the AIR DIRECTION button.

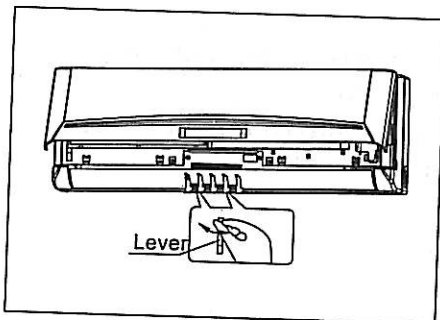

To set the horizontal air flow direction (left - right)

Adjust the vertical louver manually using the lever on the left or right side of the vertical louver arm (Depending on model). Take care not to catch fingers on the fan, horizontal louver or to damage vertical louvers. When the air conditioner is in operation and the horizontal louver is in a specific position, move the lever at left (or right, depending on model) end of the air outlet to the desired position.

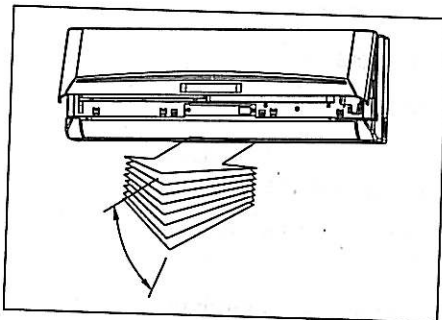

To automatically swing the air flow direction (up - down)

Perform this function while the air conditioner is in operation.

- Press the SWING button on the remote controller.
- To stop the function, press the SWING button again. Press AIR DIRECTION button to lock louver in desired position.

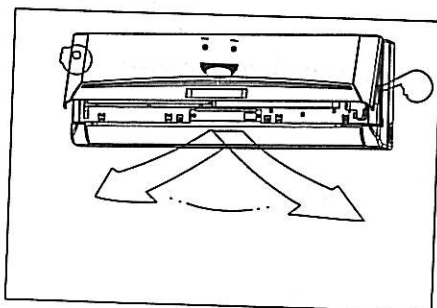

CAUTION

- The AIR DIRECTION and SWING buttons will be disabled when the air conditioner is not in operation (including when the TIMER ON is set).
- Do not operate the air conditioner for long periods with the air flow direction set downward in cooling or dry mode. Otherwise, condensation may occur on the surface of the horizontal louver causing moisture to drop on to the floor or on furnishings.
- Do not move the horizontal louver manually. Always use the AIR DIRECTION or SWING button. If you move this louver manually, it may malfunction during operation. If the louver malfunctions, stop the air conditioner once and restart it.
- When the air conditioner is started immediately after it was stopped, the horizontal louver might not move for approximately 10 seconds.
- Open angle of the horizontal louver should not be set too small, as COOLING or HEATING performance may be impaired due to too restricted air flow area.
- Do not operate unit with horizontal louver in closed position.
- When the air conditioner is connected to power (initial power), the horizontal louver may generate a sound for 10 seconds, this is a normal operation.

HOW THE AIR CONDITIONER WORKS

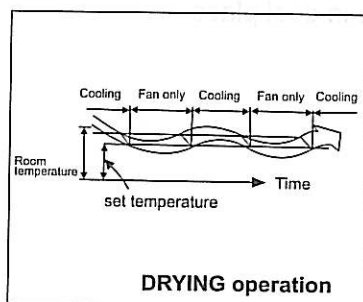
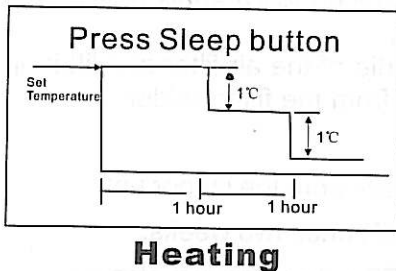
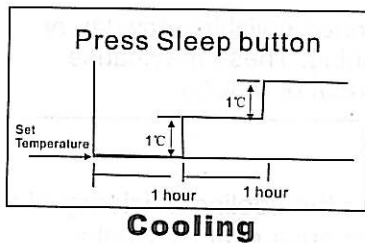

AUTOMATIC OPERATION

- When you set the air conditioner in AUTO mode, it will automatically select cooling, heating (cooling/heating models only), or fan only operation depending on what temperature you have selected and the room temperature.
- The air conditioner will control room temperature automatically round the temperature point set by you.
- If the AUTO mode is uncomfortable, you can select desired conditions manually.

SLEEP OPERATION

When you push SLEEP button during cooling, heating (cooling only type without), or AUTO operation, the air conditioner will automatically increase (cooling) or decrease (heating) 1°C per hour. The set temperature will be steady 2 hours later. The fan speed will be automatically controlled.

Note: The unit will be automatically turned off after 7 hours when on SLEEP operation.

DRYING OPERATION

- The dry mode will automatically select the drying operation based on the difference between the set temperature and the actual room temperature.
- The temperature is regulated while dehumidifying by repeating turning on and off of the cooling operation or fan only. The fan speed is LOW.

MAINTENANCE

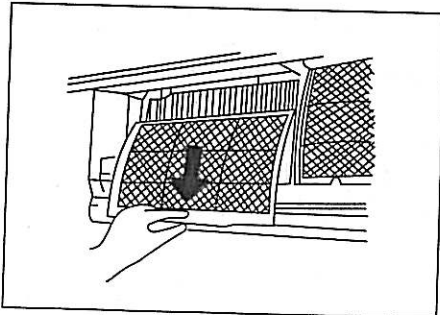
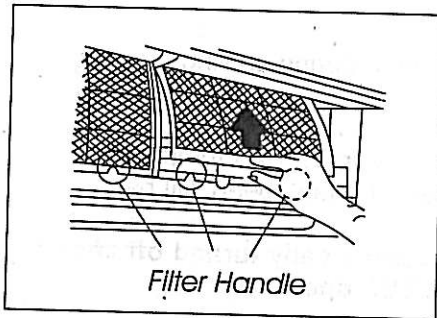
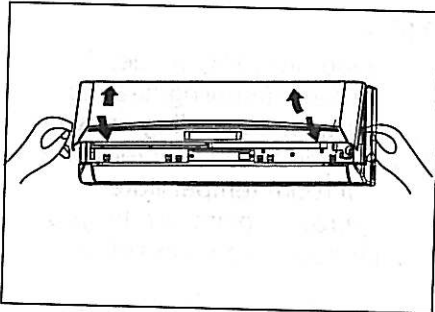
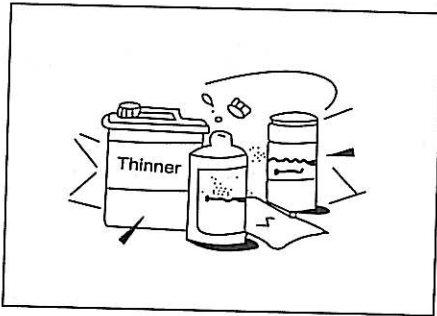
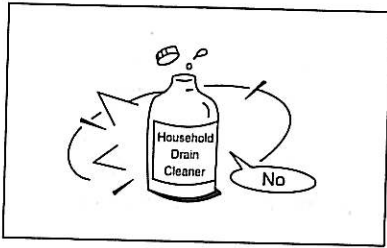

⚠ WARNING

It is necessary to stop the air conditioner and disconnect the power supply before cleaning.

Cleaning the indoor unit and remote controller

⚠ CAUTIONS

- Use a dry cloth to wipe the indoor unit and remote controller.
- A cloth dampened with cold water may be used on the indoor unit if it is very dirty.
- The front panel of the indoor unit can be removed and cleaned with water. Then wipe it with a dry cloth.
- Do not use a chemically treated cloth or duster to clean the unit.
- Do not use benzine, thinner, polishing powder, or similar solvents for cleaning. These may cause the plastic surface to crack or deform.

Cleaning the air filter

A clogged air filter reduces the cooling efficiency of this unit. Please clean the filter once every 2 weeks.

1. Lift the indoor unit panel up to an angle until it stops with a clicking sound.
2. Take hold of the handle of the air filter and lift it up slightly to take it out from the filter holder, then pull it downwards.
3. Remove the AIR FILTER from the indoor unit.
 - Clean the AIR FILTER once two weeks.
 - Clean the AIR FILTER with a vacuum cleaner or water, then dry it up in cool place.

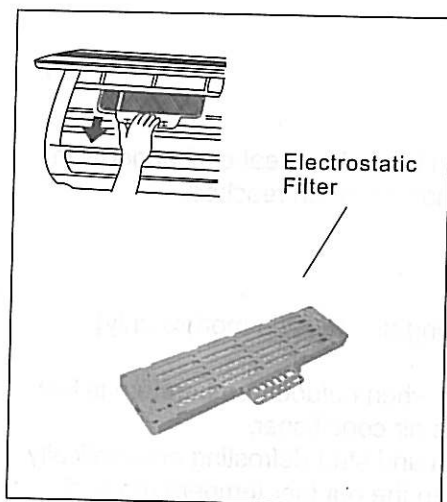

4. Remove the Electrostatic Filter from its support frame as shown in the Figure on the left (Not applicable to the units without electrostatic filter).

⚠ Do not touch this Electrostatic Filter within 10 minutes after opening the inlet grille, it may cause an electric shock.

- Clean the Electrostatic Filter with mild detergent or water and dry in the sunlight for two hours.
 - Before re-install the Electrostatic Filter, check whether the corona line or support frame is damaged or not.
5. Install the air freshening filter back into position.
 6. Insert the upper portion of air filter back into the unit taking care that the left and right edges line up correctly and place filter into position.

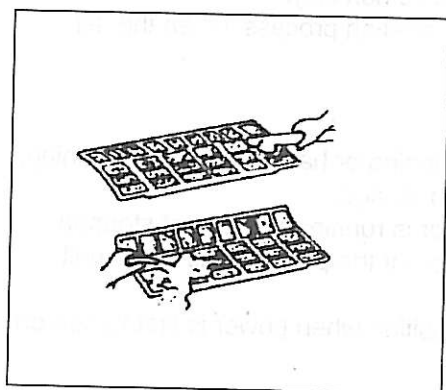

Maintenance

If you plan to idle the unit for a long time, perform the following:

- (1) Operate the fan for about half a day to dry the inside of the unit.
- (2) Stop the air conditioner and disconnect power. Remove the batteries from the remote controller.
- (3) The outdoor unit requires periodic maintenance and cleaning. Do not attempt to do this yourself. Contact your dealer or servicer.

Checks before operation

- Check that the wiring is not broken off or disconnected.
- Check that the air filter is installed.
- Check if the air outlet or inlet is blocked after the air conditioner has not been used for a long time.

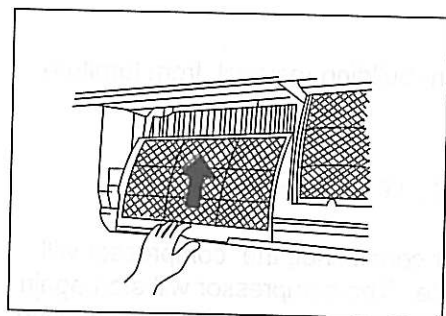

⚠ CAUTIONS

- Do not touch the metal parts of the unit when removing the filter. Injuries can occur when handling sharp metal edges.
- Do not use water to clean inside the air conditioner. Exposure to water can destroy the insulation, leading to possible electric shock.
- When cleaning the unit, first make sure that the power and circuit breaker are turned off.

OPERATION TIPS

The following events may occur during normal operation.

1. Protection of the air conditioner.

Compressor protection

- The compressor can't restart for 3 minutes after it stops.
- Anti-cold air (Cooling and heating models only)
- The unit is designed not to blow cold air on HEAT mode, when the indoor heat exchanger is in one of the following three situations and the set temperature has not been reached.
 - A) When heating has just starting.
 - B) Defrosting.
 - C) Low temperature heating.
- The indoor or outdoor fan stop running when defrosting (Cooling and heating models only).
Defrosting (Cooling and heating models only)
- Frost may be generated on the outdoor unit during heat cycle when outdoor temperature is low and humidity is high resulting in lower heating efficiency of the air conditioner.
- During this condition air conditioner will stop heating operation and start defrosting automatically.
- The time to defrost may vary from 4 to 10 minutes according to the outdoor temperature and the amount of frost buildup on the outdoor unit.

2. A white mist coming out from the indoor unit

- A white mist may generate due to a large temperature difference between air inlet and air outlet on COOL mode in an indoor environment that has a high relative humidity.
- A white mist may generate due to moisture generated from defrosting process when the air conditioner restarts in HEAT mode operation after defrosting.

3. Low noise of the air conditioner

- You may hear a low hissing sound when the compressor is running or has just stopped running. This sound is the sound of the refrigerant flowing or coming to a stop.
- You can also hear a low "squeak" sound when the compressor is running or has just stopped running. This is caused by heat expansion and cold contraction of the plastic parts in the unit when the temperature is changing.
- A noise may be heard due to louver restoring to its original position when power is first turned on.

4. Dust is blown out from the indoor unit.

This is a normal condition when the air conditioner has not been used for a long time or during first use of the unit.

5. A peculiar smell comes out from the indoor unit.

This is caused by the indoor unit giving off smells permeated from building material, from furniture, or smoke.

6. The air conditioner turns to FAN only mode from COOL or HEAT (For cooling and heating models only) mode.

When indoor temperature reaches the temperature setting on air conditioner, the compressor will stop automatically, and the air conditioner turns to FAN only mode. The compressor will start again when the indoor temperature rises on COOL mode or falls on HEAT mode (For cooling and heating models only) to the set point.

7. Dripping water may generate on the surface of the indoor unit when cooling in a high relative humidity (relative humidity higher than 80%). Adjust the horizontal louver to the maximum air outlet position and select HIGH fan speed.

8. Heating mode (For cooling and heating models only)

The air conditioner draws in heat from the outdoor unit and releases it via the indoor unit during heating operation. When the outdoor temperature falls, heat drawn in by the air conditioner decreases accordingly. At the same time, heat loading of the air conditioner increases due to larger difference between indoor and outdoor temperature. If a comfortable temperature can't be achieved by the air conditioner, we suggest you use a supplementary heating device.

9. Auto-restart function

Power failure during operation will stop the unit completely.

For the unit without Auto-restart feature, when the power restores, the OPERATION indicator on the indoor unit starts flashing. To restart the operation, push the ON/OFF button on the remote controller. For the unit with Auto-restart feature, when the power restores, the unit restarts automatically with all the previous settings preserved by the memory function.

10. Lightning or a car wireless telephone operating nearby may cause the unit to malfunction. Disconnect the unit with power and then re-connect the unit with power again. Push the ON/OFF button on the remote controller to restart operation.

Troubleshooting tips

➔ Malfunctions and Solutions

Stop the air conditioner immediately if one of the following faults occur. Disconnect the power and contact the nearest customer service center.

Trouble	OPERATION indicator or other indicators flash rapidly(5 times every second) and this flash cannot be fixed by disconnecting the power, and then connect it again.
	Fuse blows frequently or circuit breaker trips frequently.
	Other objects or water penetrate the air conditioner.
	The remote controller won't work or works abnormally.
	Other abnormal situations.

Malfunctions	Cause	What should be done?
Unit does not start	Power cut	Wait for power to be restored.
	Unit may have become unplugged.	Check that plug is securely in wall receptacle.
	Fuse may have blown.	Replace the fuse.
	Battery in Remote controller may have been exhausted.	Replace the battery.
	The time you have set with timer is incorrect.	Wait or cancel timer setting.
Unit not cooling or heating (Cooling/ heating models only) room very well while air flowing out from the air conditioner	Inappropriate temperature setting.	Set temperature correctly. For detailed method please refer to "Using remote control" section.
	Air filter is blocked.	Clean the air filter.
	Doors or Windows are open.	Close the doors or windows.
	Air inlet or outlet of indoor or outdoor unit has been blocked.	Clear obstructions away first, then restart the unit.
	Compressor 3 minutes protection has been activated.	Wait.

If the trouble has not been corrected, please contact a local dealer or the nearest customer service center. Be sure to inform them of the detailed malfunctions and unit model.

**Notes: Do not attempt to repair the unit yourself.
Always consult an authorised service provider.**

